

Inserts used for insert groovers:

Dimensions	For B=	#/edges	Position	Part #	List Price
14 x 14 x 1.2	4.0, 5.0	4	spur	6-163701	\$2.32
14 x 14 x 2	8.0 up	4	spur	6-003079	\$1.72
18 x 18 x 1.95	4.0, 4-7.5	4	raker	6-163699	\$6.20
18 x 18 x 2.5	4.1 to 5.1	4	raker	6-165906	\$7.26
18 x 18 x 2.95	5.2 to 6.0	4	raker	6-013305	\$8.90
18 x 18 x 3.7	6.1 to 7.6	4	raker	6-169250	\$10.56
7.5 x 12 x 1.5	7.7 to 8.0, 8-15	2	raker	6-052543	\$1.50
9.6 x 12 x 1.5	9.8 to 10.0	2	raker	6-171163	\$2.96
10.5 x 12 x 1.5	11-21 adj.	2	raker	6-162636	\$4.62
12 x 12 x 1.5	12.6-24 adj.	4	raker	6-003080	\$2.08
20 x 12 x 1.5	20.5-40,22-39	2	raker	6-003082	\$1.86
30 x 12 x 1.5	30.5-60 adj.	2	raker	6-003083	\$2.30
50 x 12 x 1.5	50.5-100 adj.	2	raker	6-003085	\$3.20

Note: These are the "common" grade inserts. Other grades available depending on particular application.

Insert Rabetting Cutterhead, Alternate Shear — For rabbetting cuts, especially in solid wood. Alternate shear reduced the tendency for tear-out and improves the quality of cut.



Dimensions	Z/V	Cutting depth max	Part #	List Price
125 x 30 x 1 1/4"	4/4	27mm	3-061480	\$472.00
125 x 50 x 1 1/4"	4/4	27mm	3-061482	\$472.00
125 x 60 x 1 1/4" (ALU)	2/4	27mm	3-061484	\$351.75
150 x 60 x 1 1/4" (ALU)	2/4	40mm	3-061485	\$389.50

ALU denotes Aluminum Body for reduced weight

Inserts used for insert groovers:

Dimensions	For B=	#/edges	Position	Part #	List Price
14 x 14 x 2	all	4	spur	6-003079	\$1.72
30 x 12 x 1.5	30mm	2	raker	6-003083	\$2.30
50 x 12 x 1.5	50mm	2	raker	6-003085	\$3.20
60 x 12 x 1.5	60mm	2	raker	6-003086	\$4.58

Insert Rabetting Cutterhead, No Shear — For rabbetting cuts in all types of wood products including man-made material with and without shear.

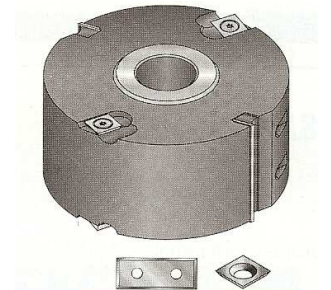

Dimensions	Z/V	Cutting depth max	Part #	List Price
85 x 50 x 1 1/4"	2/4	8mm	3-061463	\$212.00
90 x 40 x 1 1/4" (ALU)	2/4	15mm	3-061464	\$171.80
100 x 30 x 1 1/4" (ALU)	2/4	20mm	3-061460	\$255.00
100 x 50 x 1 1/4" (ALU)	2/4	20mm	3-061462	\$287.60
125 x 30 x 1 1/4"	2/4	30mm	3-061470	\$294.85
125 x 50 x 1 1/4"	2/4	50mm	3-061472	\$296.75
125 x 50 x 1 1/4" (ALU)	2/4	50mm	3-061465	\$183.10
125 x 60 x 1 1/4"	2/4	60mm	3-061467	\$249.65

ALU denotes Aluminum Body for reduced weight

Inserts used for insert groovers:

Dimensions	For B=	#/edges	Position	Part #	List Price
14 x 14 x 2	all	4	spur	6-003079	\$1.72
30 x 12 x 1.5	30mm	2	raker	6-003083	\$2.30
40 x 12 x 1.5	40mm	2	raker	6-164079	\$3.20
50 x 12 x 1.5	50mm	2	raker	6-003085	\$3.20
60 x 12 x 1.5	60mm	2	raker	6-003086	\$4.58

COGENT Flexi-Profiler — Similar to multi-profilers offered by the leading European tooling companies, the Flexi-Profiler utilizes a carbide profile knife, profiled to your specifications within the available constraints of the open tool body, plus a hardened steel backer plate also profiled to the same shape. The advantage of this type of system is that it allows for one tool to perform any number of different profiles.



The difference between the Flexi-Profiler and those offered by other companies? Our tools are designed with the U.S. market in mind, and most can be run in conjunction with inch-fractional rub collars commonly found here.

Dimensions	Z	PT(max)	Hook	Part #	List Price
125 x 40 x 1 1/4"	2	13	20°	3-167440	\$420.00
125 x 60 x 1 1/4"	2	15	20°	3-167442	\$560.00
127 x 40 x 1 1/4"	3	13	20°	3-000002	\$550.00
150 x 40 x 1 1/4"	3	13	20°	3-176184	\$450.00
150 x 60 x 1 1/4"	3	15	20°	3-176230	\$575.00
127 x 40 x 1 1/4"	3	35/64"	12°	3-000001	\$550.00
127 x 60 x 1 1/4"	3	5/8"	12°	3-000004	\$575.00
150 x 40 x 1 1/2"	4	35/64"	12°	3-000005	\$650.00
150 x 60 x 1 1/2"	4	5/8"	12°	3-000006	\$650.00

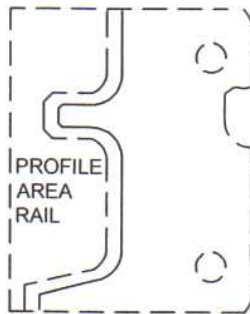
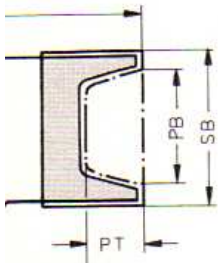

COGENT Flexi-Profiler for Cabinet Door Production — Similar to above, but we've eliminated the problem other companies fight. Most American cabinet door manufacturers design their doors with a 1/2" x 1/4" panel groove, which makes for a fragile insert and exceeds the limits of most multi-profilers. We've added a center rim, offset toward the top (allowing for use for up to 1 1/4" doors), to support the insert, allowing for even a 1/2" x 3/16" panel groove.

Dimensions		Z	PT(max)	Hook	Part #	List Price
127 x 40 x 1 1/4"	Rail	3	13	12°	3-000007	\$550.00
127 x 40 x 1 1/4"	Cope	3	13	20°	3-000008	\$550.00
150 x 40 x 1 1/2"	Rail (molder)	4	13	12°	3-000009	\$650.00

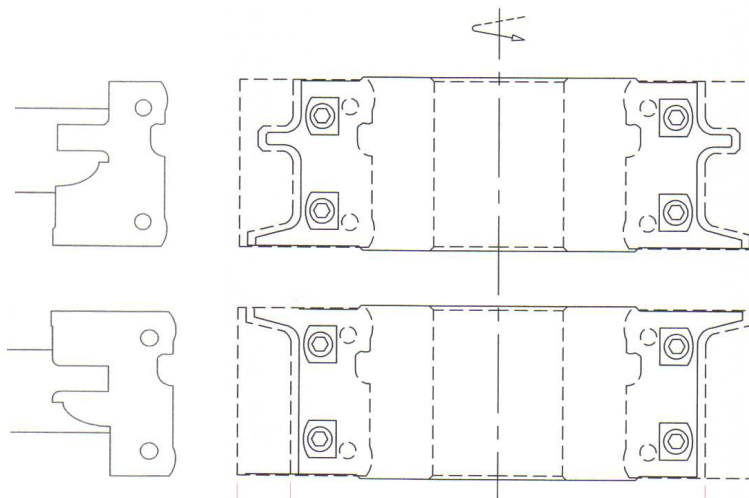
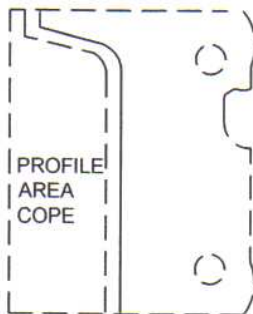

COGENT Flexi-Profiler Raised Panel System — We've taken one of our competitor's most popular tools and improved on it! The Cogent Tooling version of the Leuco-style raised panel cutterhead uses the lesser-known 50mm blank instead of the smaller 40mm blank. We've also made ours from high-tensile aircraft aluminum to further expand it's range of applications.

- Optimum hook and shear angles for a high-quality finish on end grain and along grain
- 50mm blank for increased profile range
- Compact 160-170mm (approx. 6 1/2" diameter) design, depending on the profile shape
- Designed for production of 5/8" to 1" thick panels and up to 1 3/4" entry doors
- Available in face up or face down configuration
- High-tensile aircraft aluminum body allows for use on smaller shapers (1" T-bushings available) and CNC routers (arbors available). Also creates less stress on the machine when multiple tools are stacked on the spindle
- Face up and face down versions can be stacked together to produce entry door panels in one pass
- Optional end trim cutter can be supplied for production of arched panels
- Standard bearing set allows for varied tongue lengths
- 8 standard profiles available, **or create your own** and we'll make custom knives to your profile
- Optional back cutter available

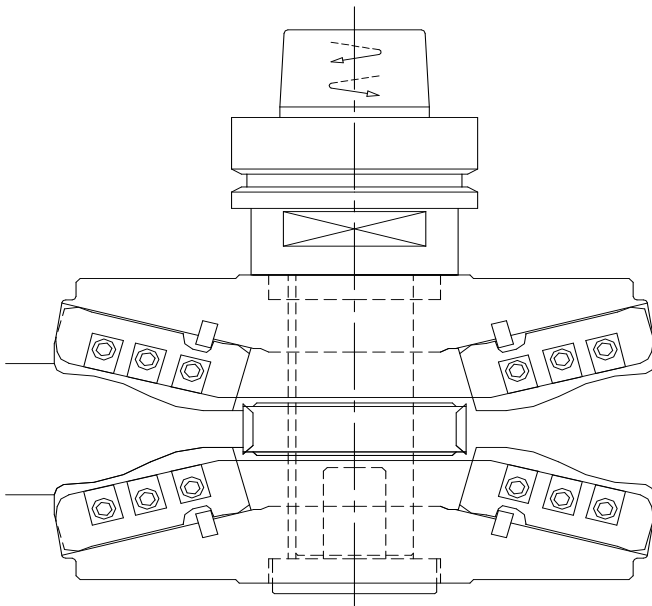
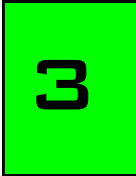

Example of face up and face down cutters with center sizing cutter mounted on HSK 63F arbor for production of entry doors.

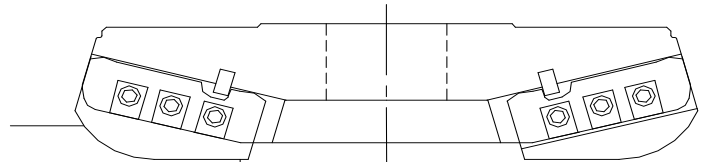

Example of face up cutter for common production of rectangular cabinet door panels.

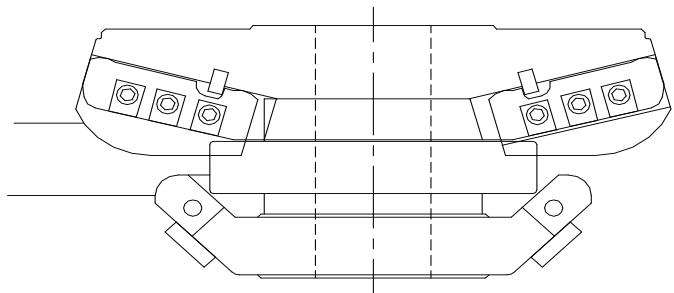

Example of face up cutter with rub collar and optional back cutter for production of flush back cathedral-top cabinet door panels.

See following pages for part numbers, prices, and profile examples.

COGENT Flexi-Profiler Raised Panel System — continued

Flexi-Profiler Raised Panel Cutterheads

Dimensions	Z	Configuration	Part #	List Price
160 x 50 x 30DKN	3	Face Up (RH)	3-000063	\$799.00
160 x 50 x 30DKN	3	Face Down (RH)	3-000064	\$799.00
160 x 50 x 1 1/4"	3	Face Up (RH)	3-000086	\$799.00
160 x 50 x 1 1/4"	3	Face Down (RH)	3-000087	\$799.00

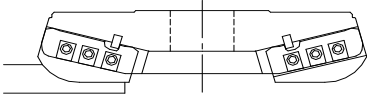

Profile Inserts for above:

Dimensions	Profile	Part #	List Price
51 x 27 x 1.5	all standard profiles (see following pages)	all	\$36.00
50mm backers	all standard profiles (see following pages)	all	\$40.00
51 x 35 x 1.5	any custom profile	TBD	\$40.00
50mm backers	any custom profile	TBD	\$44.00

End Trim Cutters for Sizing Panel in One Operation

Dimensions	Z	Part #	List Price
57 x 14.3 x 30 DKN	3	3-000065	\$399.00
57 x 14.3 x 1 1/4"	3	3-000088	\$399.00
70 x 14.3 x 30DKN	3	TBD	\$399.00
70 x 14.3 x 1 1/4"	3	TBD	\$399.00

note: custom larger or smaller end trim cutters available to alter tongue length

Inserts for end trim cutters:

Dimensions	# of edges	Part #	List Price
14.3 x 14.3 x 2.5	4	6-170248	\$3.52

Back Cutters

Dimensions	Z	Part #	List Price
Custom according to your needs		TBD	\$599.00

Accessories

Description	Part #	List Price
2.5" x 1 1/4" Bearing/Retainer	8-061650	\$37.50
2.5" x 1" Bearing/Retainer	8-061652	\$37.50
75mm Rub Collar	8-061600	\$29.50
80mm Rub Collar	8-061602	\$29.50
85mm Rub Collar	8-061604	\$29.50
90mm Rub Collar	8-061606	\$29.50
95mm Rub Collar	8-061608	\$29.50
100mm Rub Collar	8-061610	\$29.50
Bearing set of all of the above (2.5" to 100mm) x 1 1/4" bore	8-123456	\$210.00
Bearing set of all of the above (2.5" to 100mm) x 1" bore	8-123457	\$210.00
1 1/4" to 1" Short Flange bushing set for cutter only	8-002011	\$13.50
1 1/4" to 1" Long Flange bushing set for cutter set	8-002012	\$21.00
Precision Steel Spacer Set .827" thick x 1 1/4 bore	9-161796	\$100.00
Precision Steel Spacer Set 1.575" thick x 30DKN bore	9-300401	\$92.13

See section 8 for HSK63F, ISO30, etc. router arbors for use on CNC routers — 80mm long needed for 2-sided entry door production, 40mm long needed for single-sided cabinet door production.

COGENT Flexi-Profiler Raised Panel System — continued

Cabinet Door Standard Profiles—5/8" and 3/4" thick— Actual Size

Choose the correct rub collar according to how long you want the tongue to be. In-between sizes (75mm, 85mm, 95mm) are also available.

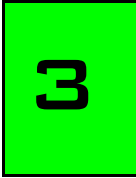

7/8" Radius Cove

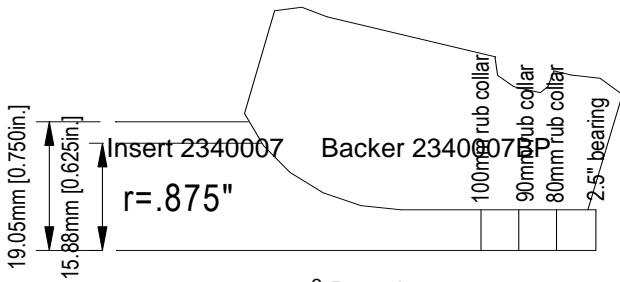

1" Radius Cove

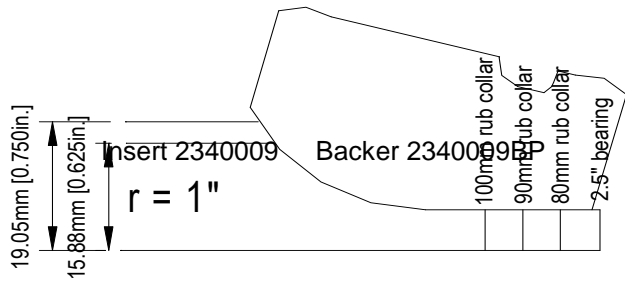

4° Bevel Ogee & Cove

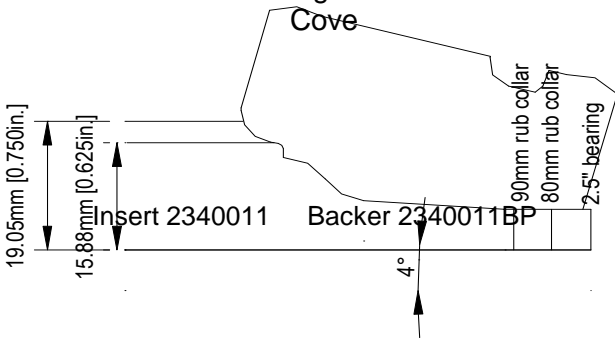

1 1/2" Radius Cove

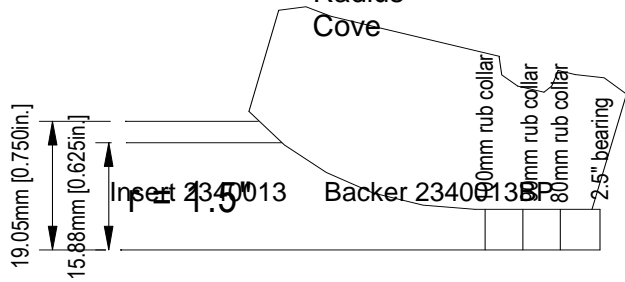

Ogee, Bevel & Cove

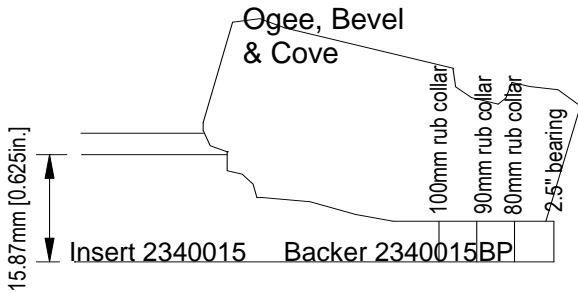

15° Bevel

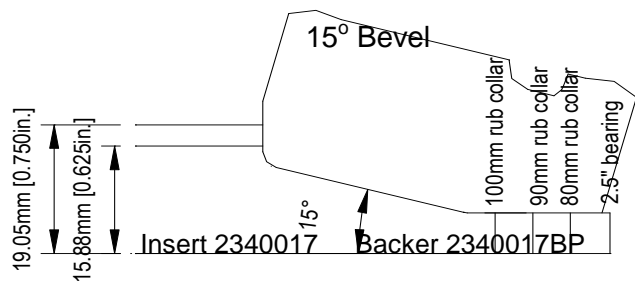

11° Bevel

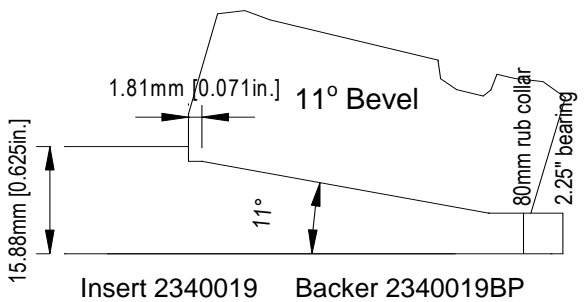

Ogee

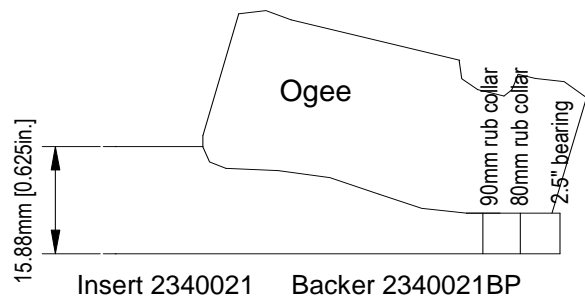

Entry Door Standard Profiles— Actual Size

Profiles shown with 3/8" tongue thickness in each case for comparison. Tongue thickness (and hence, panel thickness) can be adjusted with spacers. Tongue length shown using one of two standard end trim cutters (57mm or 70mm). For rectangular panels, end trim is not necessary. For arched panels, tongue length can be varied using custom end trim cutters.

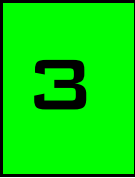

Insert 2340009
Backer 2340009BP

Insert 2340013
Backer 2340013BP

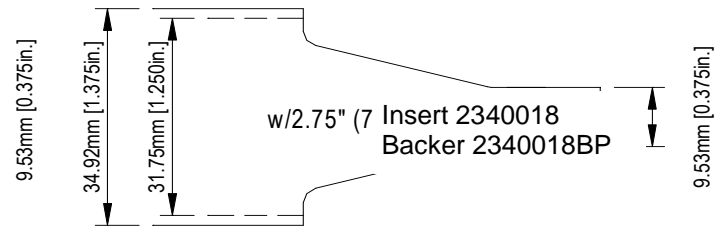
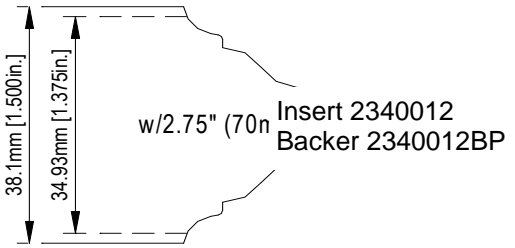
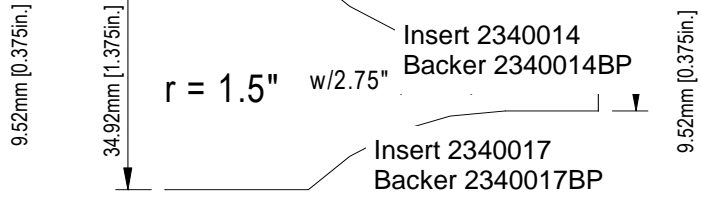
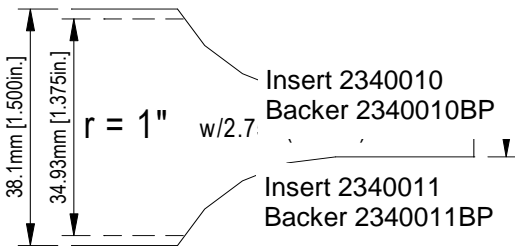

Insert 2340015
Backer 2340015BP

Insert 2340019
Backer 340019BP

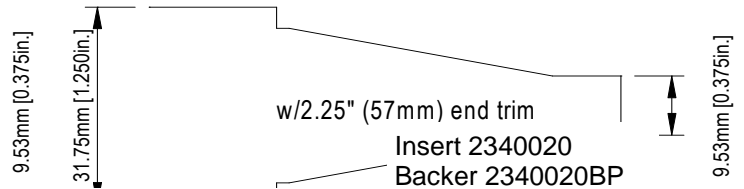
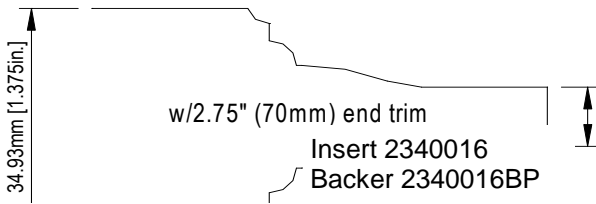

Insert 2340005
Backer 2340005BP

Insert 2340021
Backer 2340021BP

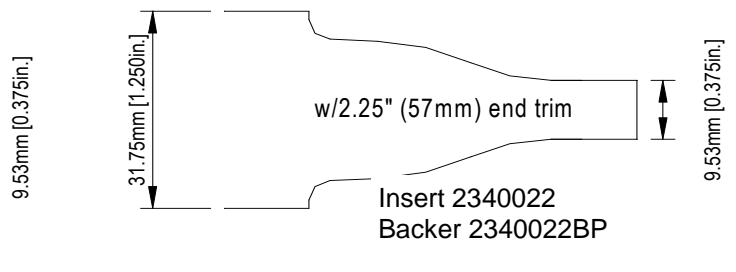
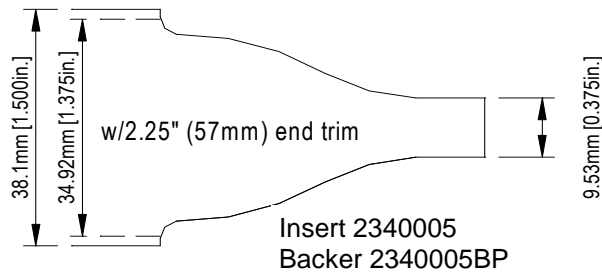

Cogent Powerlock Tooling

A certain machinery manufacturer would like you to believe that you have to order your Powerlock tools from them. Not so. In fact, what they don't widely publicize is the fact that they have their own list of over 30 "**PowerLock Partner**" licensed tool manufacturers. All of our tooling is manufactured by suppliers on their list. Many of these supplier offer tooling that exceeds the level of innovation previously offered in the United States.

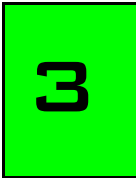

HSK85W Powerlock Spiral Planerheads by STARK Available in steel body with integrated Powerlock taper or Aluminum body mounted on a Powerlock arbor. These heads are a vast improvement over the heads offered by the machinery manufacturer. The knives are not only arranged helically, but are on a shear the way the 15 x 15 x 2.5 radiused knife was intended to be used, resulting in reduced cutting pressure, reduced noise, and improved finish as compared to theirs. **Pricing not yet available at time of publication.** Available in RH/Top or LH/Bottom configuration. Approved for up to 12,000 rpm.



Steel Body Version

Dia.	Width	Position	Part #	Position	Part #	NET Price Ea.
100	80	RH/Top	3-007202	LH/Bot	3-007201	Please Call
100	100	RH/Top	3-007204	LH/Bot	3-007203	Please Call
100	130	RH/Top	3-007206	LH/Bot	3-007205	Please Call
100	150	RH/Top	3-007208	LH/Bot	3-007207	Please Call
100	170	RH/Top	3-007210	LH/Bot	3-007209	Please Call
100	180	Top	3-007212	Bottom	3-007211	Please Call
100	190	Top	3-007214	Bottom	3-007213	Please Call
100	210	Top	3-007216	Bottom	3-007215	Please Call
100	240	Top	3-007218	Bottom	3-007217	Please Call

Aluminum Body Version

Dia.	Width	Position	Part #	Position	Part #	NET Price Ea.
100	80	RH/Top	3-007232	LH/Bot	3-007231	Please Call
100	100	RH/Top	3-007234	LH/Bot	3-007233	Please Call
100	130	RH/Top	3-007236	LH/Bot	3-007235	Please Call
100	150	RH/Top	3-007238	LH/Bot	3-007237	Please Call
100	170	RH/Top	3-007240	LH/Bot	3-007239	Please Call
100	180	Top	3-007242	Bottom	3-007241	Please Call
100	190	Top	3-007244	Bottom	3-007243	Please Call
100	210	Top	3-007246	Bottom	3-007245	Please Call
100	240	Top	3-007248	Bottom	3-007247	Please Call

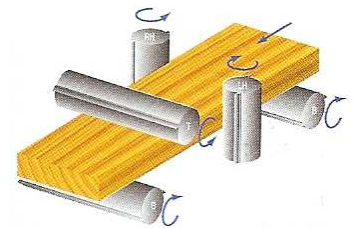

Inserts used Spiral Planer Heads:

Dimensions	#/edges	Part #	List Price
15 x 15 x 2.5 R=150	4	6-101540	\$3.95

HSK85W Powerlock Plannex Centrifugal Planerheads by STARK The patented centrifugal fixing system allows for fast and precise knife change. Available in 2-wing or 4-wing versions. Knives available in HSS or carbide for use on all wood products.

Pricing not yet available at time of publication. Available in RH/Top or LH/Bottom configuration. Approved for up to 12,000 rpm. Available in aluminum body design, mounted on an arbor upon request.

2-wing Version

Dia.	Width	Position	Part #	Position	Part #	NET Price Ea.
90	60	RH/Top	3-007320	LH/Bot	3-007319	Please Call
90	80	RH/Top	3-007302	LH/Bot	3-007301	Please Call
90	100	RH/Top	3-007304	LH/Bot	3-007303	Please Call
90	130	RH/Top	3-007306	LH/Bot	3-007305	Please Call
90	150	RH/Top	3-007308	LH/Bot	3-007307	Please Call
90	170	RH/Top	3-007310	LH/Bot	3-007309	Please Call
90	180	Top	3-007312	Bottom	3-007311	Please Call
90	190	Top	3-007314	Bottom	3-007313	Please Call
90	210	Top	3-007316	Bottom	3-007315	Please Call
90	240	Top	3-007318	Bottom	3-007317	Please Call

4-wing Version

Dia.	Width	Position	Part #	Position	Part #	NET Price Ea.
90	60	RH/Top	3-007360	LH/Bot	3-007359	Please Call
90	80	RH/Top	3-007342	LH/Bot	3-007341	Please Call
90	100	RH/Top	3-007344	LH/Bot	3-007343	Please Call
90	130	RH/Top	3-007346	LH/Bot	3-007345	Please Call
90	150	RH/Top	3-007348	LH/Bot	3-007347	Please Call
90	170	RH/Top	3-007350	LH/Bot	3-007349	Please Call
90	180	Top	3-007352	Bottom	3-007351	Please Call
90	190	Top	3-007354	Bottom	3-007353	Please Call
90	210	Top	3-007356	Bottom	3-007355	Please Call
90	240	Top	3-007358	Bottom	3-007357	Please Call

Knives used Plannex Planer Heads:

Dimensions	HSS Part #	HSS List Price	TC Part #	TC List Price
60 x 14 x 2.2	TBD	TBD	TBD	TBD
80 x 14 x 2.2	6-008001	\$13.40	6-018001	\$51.65
100 x 14 x 2.2	6-008002	\$16.70	6-018002	\$64.50
130 x 14 x 2.2	6-008004	\$21.80	6-018004	\$83.80
150 x 14 x 2.2	6-008006	\$25.10	6-018006	\$96.70
170 x 14 x 2.2	6-008007	\$28.40	6-018007	\$110.55
180 x 14 x 2.2	6-008008	\$30.00	6-018008	\$116.00
190 x 14 x 2.2	6-008009	\$31.70	6-018009	\$122.25
210 x 14 x 2.2	TBD	TBD	TBD	TBD
240 x 14 x 2.2	6-008012	\$39.95	6-018012	\$161.05

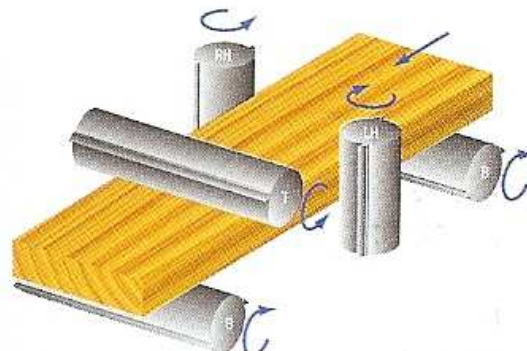

HSK85W Powerlock Corrugated Cutterheads — Available in 2-wing or 4-wing versions, for RH/Top or LH/Bottom configurations. Accepts any 1/4", 8mm corrugated knives with standard 16-60° corrugations. Standard heads are 22° hook; 12° or 12°/20° heads are available by special order at standard pricing. Approved for up to 12,000 rpm.



Note: Because of the competitive nature of these products, these items are NOT subject to normal discounts. All Powerlock corrugated head prices are NET!!!

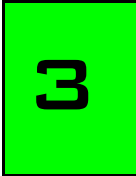

Dia.	Width	Z	Position	Part #	Position	Part #	NET Price Ea.
90	40	2	RH/Top	3-000372	LH/Bot	3-000371	\$400.00
90	60	2	RH/Top	3-000320	LH/Bot	3-000319	\$410.00
90	80	2	RH/Top	3-000302	LH/Bot	3-000301	\$430.00
90	100	2	RH/Top	3-000304	LH/Bot	3-000303	\$470.00
90	130	2	RH/Top	3-000306	LH/Bot	3-000305	\$510.00
90	150	2	RH/Top	3-000308	LH/Bot	3-000307	\$540.00
90	170	2	RH/Top	3-000310	LH/Bot	3-000309	\$580.00
90	180	2	Top	3-000312	Bottom	3-000311	\$585.00
90	190	2	Top	3-000374	Bottom	3-000373	\$590.00
90	210	2	Top	3-000316	Bottom	3-000315	\$650.00
90	240	2	Top	3-000318	Bottom	3-000317	\$700.00
90	40	4	RH/Top	3-000376	LH/Bot	3-000375	\$515.00
90	60	4	RH/Top	3-000370	LH/Bot	3-000369	\$520.00
90	80	4	RH/Top	3-000352	LH/Bot	3-000351	\$575.00
90	100	4	RH/Top	3-000354	LH/Bot	3-000353	\$645.00
90	130	4	RH/Top	3-000356	LH/Bot	3-000355	\$722.00
90	150	4	RH/Top	3-000358	LH/Bot	3-000357	\$781.00
90	170	4	RH/Top	3-000360	LH/Bot	3-000359	\$862.00
90	180	4	Top	3-000362	Bottom	3-000361	\$882.00
90	190	4	Top	3-000378	Bottom	3-000377	\$902.00
90	210	4	Top	3-000364	Bottom	3-000363	\$995.00
90	240	4	Top	3-000366	Bottom	3-000365	\$1030.00

See section 6 for knife options

Also available for Powerlock Machines — See Section 8

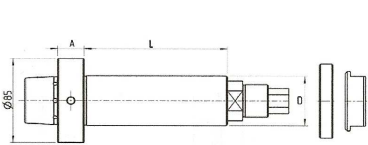

Cutter Arbor for mounting existing Tools — Weinig style with for use with Weinig Combi-Spanner

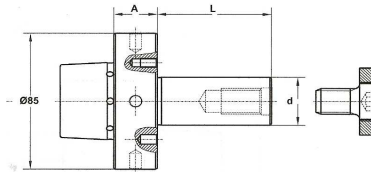

Cutter Arbor for more permanent of mounting existing Tools — double nut style with pinholes and tapped and threaded holes for secure semi-permanent attachment of tools.

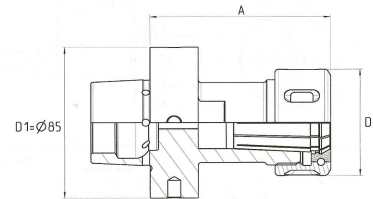

ER40 collet chuck allows for use of a wide range of router tooling, opening up a whole new range of standard tools available for your machine.